

 **texi**®



 **texi**® *Fox 25*

 *sprytne szycie*

# texi Fox 25

Automatyczna, wieloczynnościowa maszyna do szycia

główne funkcje:

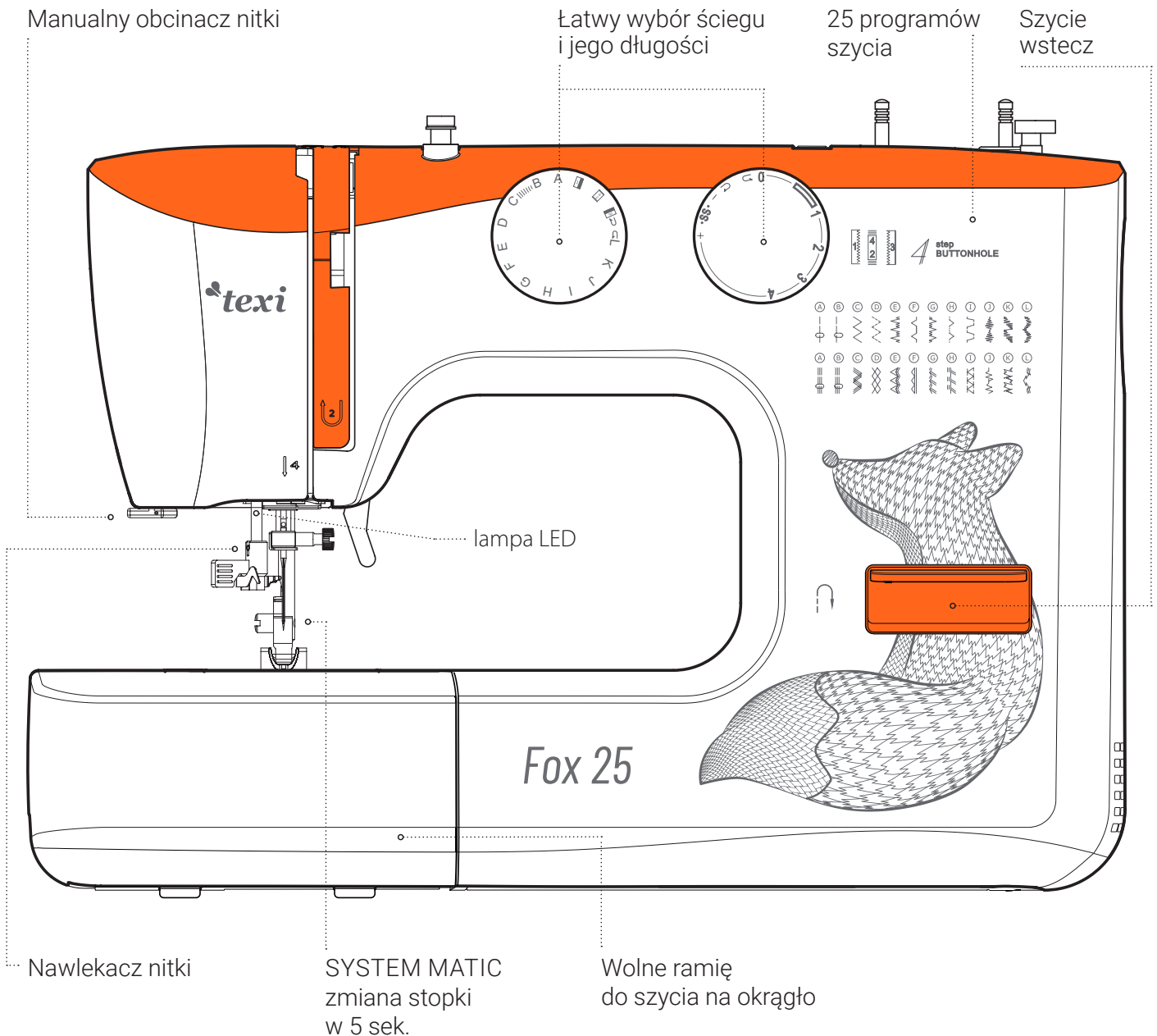

25 programów szycia (m.in. proste, zygzak i dekoracyjne oraz obszywanie dziurki pod wymiar guzika, szerokość ściegu typu zygzak do 4 mm)

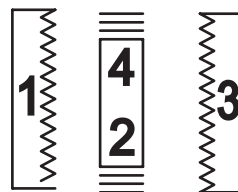
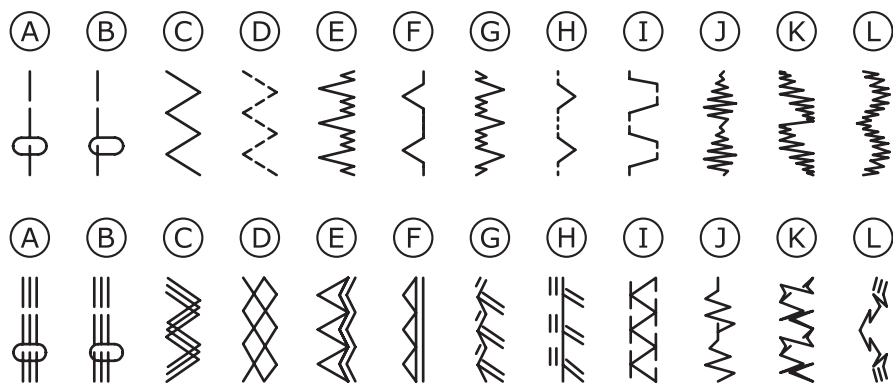

akcesoria w zestawie:

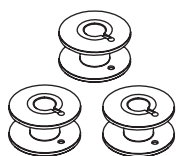

Dodatkowe szpulki  
- 3 sztuki

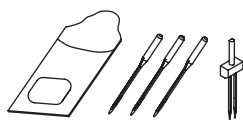

Zestaw igieł

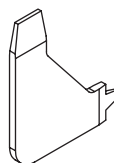

Wielofunkcyjny  
śrubokręt

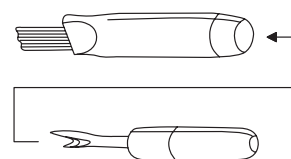

Szczoteczka  
do czyszczenia  
z rozpruwaczem szwu

zawiera zestaw szybkowymiennych  
stopki SYSTEM MATIC

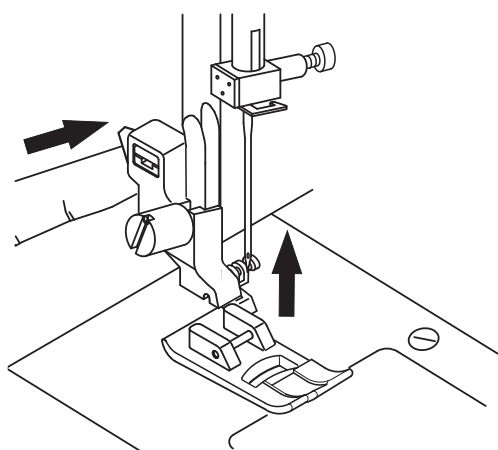

stopki w zestawie:

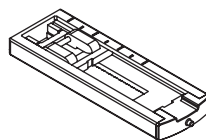

Stopka do obszywania  
dziurek

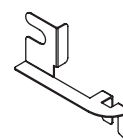

Prowadnik

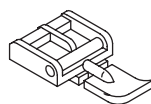

Stopka do wszywania  
zamek

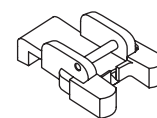

Stopka do przyszywania  
guzików

polecamy również:

produkty dostępne na  
**www.strima.com**

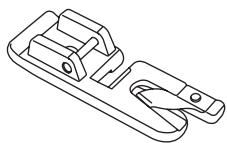

Stopka MATIC  
podwójnie zwijająca  
TEXI 1010



Stopka do zszywania  
i marszczenia  
TEXI 0010

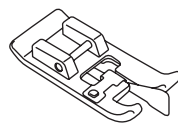

Stopka MATIC  
do ściegu overlokowego  
TEXI 1013

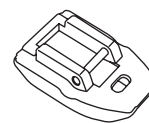

Stopka MATIC do wszywania  
zamków krytych  
TEXI 1015

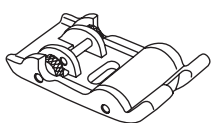

Stopka MATIC z rolkami  
do trudnych materiałów  
TEXI 1016

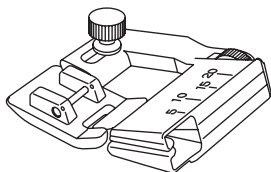

Stopka MATIC do wszywania  
zapasowanej lamówki  
TEXI 1017



Obcinaczki do nitki  
TEXI 4022

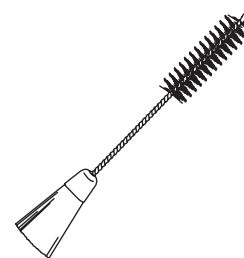

Pędzelek  
do czyszczenia maszyn  
TEXI 4017

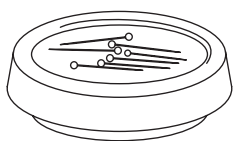

Magnetyczna  
poduszka do igieł  
i szpilek  
TEXI 4029

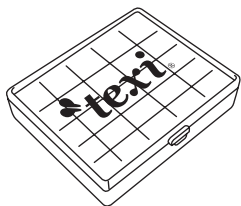

Pudełko  
na 25 szpilek  
TEXI 4033



Torba do maszyny domowej  
ENJOY BAG FOR HOUSEHOLD SEWING MACHINE